



INTERNATIONAL APPLICATION PUBLISHED UNDER THE PATENT COOPERATION TREATY (PCT)

<p>(51) International Patent Classification ⁶ : G01N 27/42, 27/52, 27/49</p>	<p>A1</p>	<p>(11) International Publication Number: WO 97/18465 (43) International Publication Date: 22 May 1997 (22.05.97)</p>
<p>(21) International Application Number: PCT/AU96/00723 (22) International Filing Date: 15 November 1996 (15.11.96) (30) Priority Data: PN 6619 16 November 1995 (16.11.95) AU (71) Applicant (for all designated States except US): MEMTEC AMERICA CORPORATION [US/US]; Suite 700, 9690 Deereco Road, Timonium, MD 21903 (US). (72) Inventors; and (75) Inventors/Applicants (for US only): HODGES, Alastair, McIndoe [AU/AU]; 34 Samuel Road, Blackburn South, VIC 3130 (AU). BECK, Thomas, William [AU/AU]; 31 Drummond Street, South Windsor, NSW 2756 (AU). JOHANSEN, Oddvar [NO/AU]; 16 Damley Grove, Mulgrave, VIC 3170 (AU). MAXWELL, Ian, Andrew [AU/AU]; 3 Whiting Street, Leichhardt, NSW 2040 (AU). (74) Agent: SHELSTON WATERS; 60 Margaret Street, Sydney, NSW 2000 (AU).</p>		<p>(81) Designated States: AL, AM, AT, AU, AZ, BA, BB, BG, BR, BY, CA, CH, CN, CU, CZ, DE, DK, EE, ES, FI, GB, GE, HU, IL, IS, JP, KE, KG, KP, KR, KZ, LC, LK, LR, LS, LT, LU, LV, MD, MG, MK, MN, MW, MX, NO, NZ, PL, PT, RO, RU, SD, SE, SG, SI, SK, TJ, TM, TR, TT, UA, UG, US, UZ, VN, ARIPO patent (KE, LS, MW, SD, SZ, UG), Eurasian patent (AM, AZ, BY, KG, KZ, MD, RU, TJ, TM), European patent (AT, BE, CH, DE, DK, ES, FI, FR, GB, GR, IE, IT, LU, MC, NL, PT, SE), OAPI patent (BF, BJ, CF, CG, CI, CM, GA, GN, ML, MR, NE, SN, TD, TG).</p> <p>Published With international search report.</p>
<p>(54) Title: ELECTROCHEMICAL METHOD</p>		
<p>(57) Abstract</p> <p>A method for determining the concentration of a reduced or oxidized form of a redox species in an electrochemical cell of the kind comprising a working electrode and a counter electrode spaced from the working electrode such that reaction products from the counter electrode arrive at the working electrode, the method comprising the steps of applying (21) an electric potential between the electrodes, such that the electro-oxidation of the redox species is diffusion controlled, determining the current as a function of time, estimating the magnitude of the steady state current (23), reversing the potential, again determining current as a function of time and estimating the reverse potential steady state (25).</p>		

FOR THE PURPOSES OF INFORMATION ONLY

Codes used to identify States party to the PCT on the front pages of pamphlets publishing international applications under the PCT.

AM	Armenia	GB	United Kingdom	MW	Malawi
AT	Austria	GE	Georgia	MX	Mexico
AU	Australia	GN	Guinea	NE	Niger
BB	Barbados	GR	Greece	NL	Netherlands
BE	Belgium	HU	Hungary	NO	Norway
BF	Burkina Faso	IE	Ireland	NZ	New Zealand
BG	Bulgaria	IT	Italy	PL	Poland
BJ	Benin	JP	Japan	PT	Portugal
BR	Brazil	KE	Kenya	RO	Romania
BY	Belarus	KG	Kyrgyzstan	RU	Russian Federation
CA	Canada	KP	Democratic People's Republic of Korea	SD	Sudan
CF	Central African Republic	KR	Republic of Korea	SE	Sweden
CG	Congo	KZ	Kazakhstan	SG	Singapore
CH	Switzerland	LI	Liechtenstein	SI	Slovenia
CI	Côte d'Ivoire	LK	Sri Lanka	SK	Slovakia
CM	Cameroon	LR	Liberia	SN	Senegal
CN	China	LT	Lithuania	SZ	Swaziland
CS	Czechoslovakia	LU	Luxembourg	TD	Chad
CZ	Czech Republic	LV	Latvia	TG	Togo
DE	Germany	MC	Monaco	TJ	Tajikistan
DK	Denmark	MD	Republic of Moldova	TT	Trinidad and Tobago
EE	Estonia	MG	Madagascar	UA	Ukraine
ES	Spain	ML	Mali	UG	Uganda
FI	Finland	MN	Mongolia	US	United States of America
FR	France	MR	Mauritania	UZ	Uzbekistan
GA	Gabon			VN	Viet Nam

TITLE: ELECTROCHEMICAL METHOD**FIELD OF THE INVENTION**

This invention relates to an electrochemical method for determining the concentration of an analyte in a carrier and to apparatus suitable for use in conducting
5 the method.

BACKGROUND ART

The invention herein described is an improvement in or modification of the invention described in our co-pending application PCT/AU96/00365, the contents of which are incorporated herein by reference.

10 The invention will herein be described with particular reference to a biosensor adapted to measure the concentration of glucose in blood, but it will be understood not to be limited to that particular use and is applicable to other analytic determinations.

It is known to measure the concentration of a component to be analysed in an aqueous liquid sample by placing the sample into a reaction zone in an electrochemical
15 cell comprising two electrodes having an impedance which renders them suitable for

amperometric measurement. The component to be analysed is allowed to react directly with an electrode, or directly or indirectly with a redox reagent whereby to form an oxidisable (or reducible) substance in an amount corresponding to the concentration of the component to be analysed. The quantity of the oxidisable (or reducible) substance present is then estimated electrochemically. Generally this method requires sufficient separation of the electrodes so that electrolysis products at one electrode cannot reach the other electrode and interfere with the processes at the other electrode during the period of measurement.

In our co-pending application we described a novel method for determining the concentration of the reduced (or oxidised) form of a redox species in an electrochemical cell of the kind comprising a working electrode and a counter (or counter/reference) electrode spaced from the working electrode. The method involves applying an electrical potential difference between the electrodes, spacing the working electrode from the counter electrode so that reaction products from the counter electrode arrive at the working electrode and selecting the potential of the working electrode so that the rate of electro-oxidation of the reduced form of the species (or of electro-reduction of the oxidised form) is diffusion controlled. By determining the current as a function of time after application of the potential and prior to achievement of a steady state current and then estimating the magnitude of the steady state current, the method previously described allows the diffusion coefficient and/or the concentration of the reduced (or oxidised) form of the species to be estimated.

Our co-pending application exemplifies this method with reference to use of a "thin layer" cell employing a GOD/Ferrocyanide system. As herein used, the term "thin

layer electrochemical cell" refers to a cell having closely spaced electrodes such that reaction products from the counter electrode arrive at the working electrode. In practice, the separation of electrodes in such a cell for measuring glucose in blood will be less than 500 microns, and preferably less than 200 microns.

5 The chemistry used in the exemplified electrochemical cell is as follows:



where GOD is the enzyme glucose oxidase, and GOD* is the 'activated' enzyme.

Ferricyanide ($[\text{Fe}(\text{CN})_6]^{3-}$) is the 'mediator' which returns the GOD* to its catalytic

10 state. GOD, an enzyme catalyst, is not consumed during the reaction so long as excess mediator is present. Ferrocyanide ($[\text{Fe}(\text{CN})_6]^{4-}$) is the product of the total reaction.

Ideally there is initially no ferrocyanide, although in practice there is often a small quantity. After reaction is complete the concentration of ferrocyanide (measured electrochemically) indicates the initial concentration of glucose. The total reaction is the

15 sum of reactions 1 and 2:

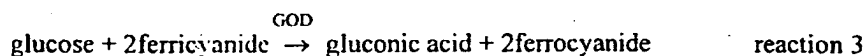

"Glucose" refers specifically to β -D-glucose.

20 The prior art suffers from a number of disadvantages. Firstly, sample size required is greater than desirable. It would be generally preferable to be able to make measurements on samples of reduced volume since this in turn enables use of less invasive methods to obtain samples.

Secondly, it would be generally desirable to improve the accuracy of measurement and to eliminate or reduce variations due, for example, to cell asymmetry or other factors introduced during mass production of microcells.

Thirdly, it would be generally desirable to reduce the time that is required in
 5 which to obtain a measurement. The test protocols used in current commercially available electrochemical glucose sensors involve a predetermined wait period at the beginning of the test during which the enzyme reacts with the glucose to produce the specie that is sensed electrochemically. This initial period is fixed at the maximum necessary to achieve the desired reaction under all conditions of use.

10 Fourthly, it would be desirable to eliminate variations due to oxygen. Oxygen can be plentiful in blood, either dissolved in the plasma, or bound in haemoglobin. It can also be introduced during "finger sticking", where a blood drop of small volume and high surface area is exposed to the atmosphere prior to introduction to a cell. Oxygen can interfere since oxygen is a mediator for GOD. The reaction is as follows:

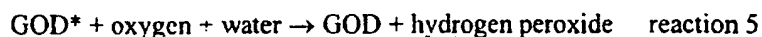
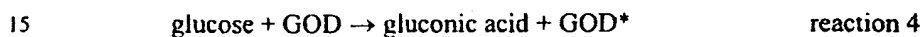

The total reaction is given by:

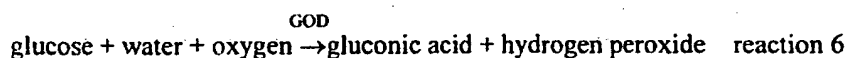

20 In most situations the complication of oxygen also acting as a mediator is unwanted, simply because the concentration of final ferrocyanide no longer is directly proportional to the concentration of initial glucose. Instead, the initial glucose concentration is then related to both the final concentration of ferrocyanide and of hydrogen peroxide.

OBJECT OF THE INVENTION

An object of the invention is to provide an improved method for determination of the concentration of an analyte in a carrier which avoids or ameliorates the disadvantages of prior art. It is an object of preferred forms of the invention to provide a biosensor of improved accuracy, and/or reliability and/or speed.

DISCLOSURE OF THE INVENTION

According to one aspect the invention consists in a method for determining the concentration of a reduced (or oxidised) form of a redox species in an electrochemical cell of the kind comprising a working electrode and a counter electrode spaced from the working electrode by a predetermined distance, said method comprising the steps of:

- (a) applying an electric potential between the electrodes, wherein the electrodes are spaced so that reaction products from the counter electrode arrive at the working electrode by diffusion and wherein the potential of the working electrode is such that the rate of the electro-oxidation of the reduced form (or oxidised form) of the redox species is diffusion controlled.
- (b) determining current as a function of time after application of the potential and prior to achievement of a steady state,
- (c) estimating the magnitude of the steady state current,
- (d) interrupting, or reversing the polarity, of the potential,
- (e) repeating step (b) and step (c).

The invention stems from the discovery that if the polarity is reversed (ie the anode becomes the cathode and vice versa) after the initial steady state current is achieved, then a second transient current can be observed and after a period of time a

second steady state is achieved. This has proved useful for diagnosing, and for reducing the effects of, cell asymmetry and other factors which influence the transient current. It also permits greater reliability and/or accuracy of estimation by allowing measurements to be made repetitively using reverse polarities. Likewise if the potential is interrupted
5 for a time sufficient for the concentration profile to relax to a random state and is then reapplied, steps (b) and (c) can be repeated.

According to a second aspect the invention consists in a method according to the first aspect for measuring the concentration of glucose in a sample by means of a cell having a working electrode, a counter electrode, an enzyme catalyst and a redox
10 mediator, comprising the steps of operating the cell at a potential higher than that of the redox reaction so as to oxidise hydrogen peroxide at the anode and then conducting a method according to the first aspect.

By this means the interference of oxygen can be ameliorated as explained in more detail hereinafter.

15 According to a third aspect the invention consists in a method according to the first or second aspect wherein the sample is allowed to react with an enzyme catalyst and a redox mediator comprising the steps of:

- (a) applying a potential between the electrodes before or during filling of the cell.
- (b) measuring the increase in current as a function of time,
- 20 (c) determining or predicting from the measurement in step (b) the time of completion of reaction with said catalyst, and
- (d) then interrupting or reversing the polarity of the potential.

BRIEF DESCRIPTION OF THE DRAWINGS

The invention will now be more particularly described by way of example only and with reference to the accompanying drawings wherein:

Figure 1 exemplifies the reactions taking place in a cell according to the invention.

5 Figure 2 illustrates the concentration profiles across an electrochemical cell according to the invention before the application of an electrical potential, after application of the potential and prior to reaching steady state, and at steady state.

Figure 3 shows the time dependence of current prior to and after application of electrical potential.

10 Figure 4 shows the ferrocyanide concentration profiles across an electrochemical cell according to the invention prior to a polarity reversal, after reversal and prior to reaching a steady state, and at steady state.

Figure 5 shows the time dependence of current prior to and after a polarity reversal.

15 Figure 6 shows the time dependence of current prior to and after an interruption of applied potential of 15 seconds.

Figure 7 shows the reactions in an electrochemical cell with peroxide oxidation.

Figure 8 shows the time dependence of current when an initial potential sufficient to oxidise hydrogen peroxide is applied.

20 Figure 9 describes the cell of Figure 7 in plan view.

Figure 10 describes an embodiment of a cell suitable for use in the invention in cross-section view on line 10-10 of Figure 9.

Figure 11 describes the cell of Figure 7 in end section view.

With reference to Figures 9, 10 and 11 there is shown (not to scale) by way of example only an electrochemical cell suitable for use in the method of the invention.

The cell comprises a polyester core 4 approximately 18mm x 5mm and 100 micron thick and having a circular aperture 8 of 3.4mm diameter. Aperture 8 defines a cylindrical cell side wall 10. Adhered to one side of core 4 is a polyester sheet 1 having a sputter coating of palladium 2. The sputter coating took place at between 4 and 6 millibar pressure in an atmosphere of argon gas to give a uniform coating thickness of about 100-1000 angstroms. The sheet is adhered by means of an adhesive 3 to core 4 with palladium 2 adjacent core 4 and covering aperture 8.

10 A second polyester sheet 7 having a second sputter coating of palladium 6 is adhered by means of contact adhesive 5 to the other side of core 4 and covering aperture 8. There is thereby defined a cell having cylindrical side wall 10 and closed each end by palladium metal. The assembly is notched at 9 to provide for a solution to be admitted to the cell or to be drawn in by wicking or capillary action and to allow air to escape.

15 The metal films 2, 6 are connected with suitable electrical connections or formations whereby potentials may be applied and currently measured. The cell is furnished with GOD and ferrocyanide in dry form. The cell is shown schematically in Figure 1.

In use according to the method a drop of blood is drawn into the cell at 9 by capillary action and allowed to react.

20 PREFERRED EMBODIMENTS OF THE INVENTION

The electrochemical means for measuring the ferrocyanide concentration after complete reaction can be considered by reference to figure 1.

In a thin layer cell the initial concentration of ferrocyanide and ferricyanide (after 'enzymatic' reaction is complete) is equal throughout the cell (the axis of interest being that between the electrodes). The concentration profile of ferrocyanide is given in figure 2.

5 When a particular potential is applied across the cell ferricyanide is converted to ferrocyanide at the cathode and ferrocyanide is converted to ferricyanide at the anode. The chemistry is so arranged that after complete reaction there is still an excess of ferricyanide compared to ferrocyanide. For this reason the process that limits the complete electrochemical process is the conversion of ferrocyanide to ferricyanide at the
10 anode, simply because ferrocyanide is at a significantly lower concentration. Further the rate limiting step for the reaction of ferrocyanide is the diffusion of ferrocyanide to the anode. After a period of time a steady-state is achieved, wherein the concentration profile of ferrocyanide and ferricyanide remains constant (see figure 2).

 Therefore there are two limiting situations: initially 20 the ferrocyanide is
15 evenly distributed throughout the cell. Then after a known potential is applied across the cell for a period of time a steady-state concentration profile 23 of ferrocyanide is achieved. The 'transient' 22 reflects the measured current across the cell as the concentration adjusts from the initial situation to the final steady state situation 23. This is shown as a function of time in Figure 3. It has been found that the change in the
20 current with time during this 'transient' period is dependent upon the total concentration of ferrocyanide and the diffusion coefficient of ferrocyanide.

By solving the diffusion equations for this situation, it can be shown that the transient can be adequately described by the following equation over a restricted calculable time range:

$$\ln\left(\frac{i - i_{ss}}{i_{ss}}\right) = -\frac{4\pi^2 Dt}{L^2} + \ln(2) \quad \text{Eqn 1}$$

where i is the measured current, i_{ss} is the current at steady-state, D the diffusion coefficient of ferrocyanide in the cell, L the separation distance between the anode and cathode, and t is time.

This is a simple solution of the general diffusion equation. However, it may be possible to use other solutions.

The final current at steady state also depends upon the total concentration of ferrocyanide and the diffusion coefficient of ferrocyanide. The steady state current can also be modelled by diffusion theory, and is given by:

$$i_{ss} = \frac{2DFCA}{L} \quad \text{Eqn 2}$$

where F is the Faraday constant, C the initial concentration of ferrocyanide and A the area of the working electrode. By initial concentration is meant the unperturbed concentration (shown as 20 in Figure 2).

Analysis of the current observed during the transient and also at steady state allows calculation of both the concentration and diffusion coefficient of ferrocyanide, and thus also the initial glucose concentration.

This analysis is achieved by plotting:

$$\ln\left(\frac{i - i_{ss}}{i_{ss}}\right) \quad \text{Eqn 3}$$

- 11 -

versus time which is substantially linear over a restricted and calculable time range and thus can be analysed for example by linear least squares regression. Since L is a constant for a given cell, measurement of i as a function of time and of i_{ss} thus enables the value of the diffusion coefficient of the redox mediator to be calculated and

5 the concentration of the analyte to be determined.

Another possible way to analyse the data is to use the variation of current with time soon after the potential step is applied to the electrodes. In this time period the current can be adequately described by the Cottrell equation. That is:

$$i = FAD^{1/2}C / (\pi^{1/2} t^{1/2}) \quad \text{Eqn 4}$$

10 By least squares regression on a plot of i vs $1/t^{1/2}$ a value of $FAD^{1/2}C/\pi^{1/2}$ can be estimated from the slope of this plot. The steady state current i_{ss} is given as before, so by combining the slope of the plot given above with the steady state current a value of the concentration of the ferrocyanide, independent of the diffusion coefficient of the ferrocyanide in the cell, can be estimated. This is given by:

$$15 \quad C = 2 \text{slope}^2 / (FALi_{ss}) \quad \text{Eqn 5}$$

In an example according to the present invention, a sample of blood is admitted to a thin layer cell containing a GOD/ferrocyanide system such as previously described with reference to Figures 7, 8 and 9. As illustrated in Figure 3 after allowing a short time 20 for reaction, an electric potential is applied between the electrodes, current flow commences when the potential is applied 21 but then falls as a transient 22 towards a steady state level 23. The diffusion coefficient and/or glucose concentration are derived by measuring current as a function of time and by estimating the steady state current.

According to the present invention, the current is then interrupted, or reversed

in polarity, for example by means of a suitable switch. If the polarity is reversed, a second transient is then observed, and a second steady state is reached after a further period of time although the profile is reversed. The underlying change in ferrocyanide concentration profile across the cell is shown schematically in Figure 4. The initial concentration profile prior to current reversal is 23. The new steady state concentration profile is shown at 25. The transient concentration profiles are exemplified at 24.

By solving the diffusion equations for this situation, it can be shown that the transient current is described by:

$$\ln\left(\frac{i}{i_{ss}} - 1\right) = -\frac{4\pi^2 D t}{L^2} + \ln(4) \quad \text{Eqn 6}$$

It is therefore simple to re-estimate the diffusion coefficient and concentration under the reversed polarity conditions. In theory the results should be independent of the type of transient or polarity. In practice, the results may differ due to factors affecting the transient such as sample inhomogeneity, state of the electrodes, or more importantly, due to asymmetries in the cell construction. This measure is therefore useful for cell diagnosis and also enables greater accuracy by allowing repetitive measurement and averaging with reverse polarities.

Similarly, if the potential is interrupted after steady state is reached, the initial concentration profile will be re-established in a short time (for example 4 seconds).

Once the initial state is re-established (or approximated) the potential can be re-applied and the procedure repeated without current reversal. Figure 6 shows a plot of current versus time similar to that of Figure 3 but having the potential interrupted at 26 and reapplied after 15 seconds at 27 yielding a new transient current 28 and then a state 29.

- 13 -

As stated previously, the presence of oxygen in the blood is an interference since the concentration of final ferrocyanide is then not directly proportional to the initial glucose. Instead the initial glucose is related both to the final concentration of ferrocyanide plus hydrogen peroxide. however, the present inventors have found that
5 hydrogen peroxide can be oxidised at the anode at a known potential which is higher than that for the ferrocyanide/ferricyanide redox reaction. The total electrochemical path is given in Figure 7. The hydrogen peroxide reaction is:

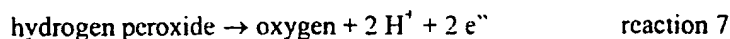

If, during the period of enzyme reaction a potential is applied (Figure 8) across
10 the cell that is sufficient to oxidise hydrogen peroxide, then the following will happen during that period:

- (a) glucose will be reacted to gluconic acid.
- (b) ferrocyanide and hydrogen peroxide will result.
- (c) the ferrocyanide/ferricyanide redox will eventually reach steady state.
- 15 (d) the peroxide will be oxidised at the anode and the electrons used to convert ferricyanide to ferrocyanide.

In total, after a period of time (approximately 2½ seconds in Figure 8) at a constant potential all the peroxide will be converted to oxygen (which is then a catalyst, and will return to complete more enzyme chemistry until glucose is exhausted), and the
20 electrons utilised to convert ferricyanide to ferrocyanide.

At this stage (60 seconds in Figure 8) a reverse transient is applied. That is, the polarity of the cells is switched, but now at the lower potential suitable for the ferricyanide/ferrocyanide redox reaction. The final steady state ferrocyanide will once

- 14 -

again reflect the initial glucose concentration. This can be analysed in the previously described manner to determine the total concentration of glucose in the initial sample.

Using the method of the invention the reaction phase of the test can be monitored in situ electrochemically without interfering with the measurement phase.

5 When the reaction is complete one can proceed to measurement without further delay. The wait time will vary from test to test and will be the minimum necessary for any particular sample and cell, taking account of changes in enzyme activity from cell to cell as well as different temperatures and glucose concentrations. This is in stark contrast to prior art in which measurement is delayed until the maximum time required for reaction
10 after allowing for all these factors.

In the present method the reaction phase is monitored by applying a potential between the two electrodes of, for example, -300mV as soon as the cell begins to fill with sample.

A linear concentration profile of the reduced mediator is soon achieved across
15 the cell. As more reduced mediator is produced by the enzyme reaction with glucose this linear concentration profile becomes steeper and the current increases. When the reaction is complete the current no longer increases. This point can be detected by well known electronic means and the measurement phase of the test can then be commenced.

The end-point of the reaction can also be estimated by fitting a theoretical
20 kinetic equation to the current versus time curve generated during this part of the test. This equation can predict the degree of completion of the reaction at any time, so would allow knowledge of when the end-point would occur without having to wait to get there. This would further shorten the test time. For example, one could fit an equation to the

measured prepulse current versus time curve. This equation could then predict that at time X the reaction will be, for example, 90% complete.. If one measures the concentration at time X one would then divide the answer by 0.90 to get the true concentration.

5 The measurement of concentration in this system is done by reversing the potential, ie applying +300mV between the electrodes. A current versus time curve will then occur, which is the same as that of the second transient in a double transient experiment ie by transforming the current i measured during the measurement phase one can obtain a plot of $\ln(i/i_{ss} - 1)$ versus time which will have a slope of $-4\pi^{1/2}D/l^{1/2}$ and
10 an intercept $\ln(4)$. The normal analysis can then be used to obtain the concentration of glucose.

In some situations it may be difficult or impossible to know the distance between the electrodes in the electrochemical cell. For example, very small separations (ca. 10 microns) may be very difficult to manufacture or measure reproducibly. In these
15 situations the use of information from two adjoining cells can be used to calculate the concentration of an analyte in a sample without knowledge of the cell separation if one of the cells contains a known concentration of the analyte or the corresponding reduced mediator prior to sample addition. Alternatively, a known quantity of this analyte or reduced mediator can be added to the sample destined for one of the two cells prior to
20 addition of the sample to the cell. Another variation is if both cells contain a pre-determined analyte or reduced mediator concentration but each has a different concentration. Yet another variation is if two different predetermined quantities of the

analyte or reduced mediator are added to two aliquots of the sample, which are then added to the adjoining cells.

The two electrochemical cells are then used in the normal fashion, and from each cell the following quantities are measured: steady state current (i_{ss}) and the slope of the straight line defined by $\ln(i/i_{ss}-1)$ versus time, where i is the measured current. With a knowledge of these values and also a knowledge of the difference in concentration of the analyte or reduced mediator between the two cells, which is known (it is equal to that value purposely added to one cell), it is possible to calculate the concentration of analyte or reduced mediator in the sample, without any knowledge of the separation distance of the electrodes.

The above can be used in conjunction with a third cell that is used to measure the background current or concentration due to current caused by, for example, reduced mediator formed by the application and drying of the chemistry, catalytic effect of the metal surface, oxidation of the metal surface, sample components that have effects on the analyte or mediator, electrochemically responsive components of the sample etc. This background concentration or current would be subtracted from the values measured from the two cells discussed above to calculate the true values for each cell resulting from the analyte in the sample, and in one case also the analyte or reduced mediator purposely added to the cell or the sample.

As will be apparent to those skilled in the art from the teaching hereof the method is suitable for use with automatic measuring apparatus. Cells of the kind described may be provided with electrical connectors to an apparatus provide with a microprocessor or other programmed electronic control and display circuits which are

adapted to make the required measurements perform the required calculations and to display the result. The method may be used to measure the concentration of analytes other than glucose and in liquids other than blood.

The method may be conducted using cells of other design and/or construction
5 and using known catalysts and redox systems other than that exemplified.

CLAIMS:-

1. A method for determining the concentration of a reduced (or oxidised) form of a redox species in an electrochemical cell of the kind comprising a working electrode and a counter electrode spaced from the working electrode by a predetermined distance, said
5 method comprising the steps of:
 - (a) applying an electric potential between the electrodes, wherein the electrodes are spaced so that reaction products from the counter electrode arrive at the working electrode by diffusion and wherein the potential of the working electrode is such that the rate of the electro-oxidation of the reduced form (or oxidised form) of the
10 redox species is diffusion controlled,
 - (b) determining current as a function of time after application of the potential and prior to achievement of a steady state,
 - (c) estimating the magnitude of the steady state current,
 - (d) interrupting, or reversing the polarity, of the potential,
 - 15 (e) repeating step (b) and step (c).
2. A method according to claim 1 wherein the polarity is reversed in step (d).
3. A method according to claim 1 or claim 2 wherein the electrodes are separated by less than 500 microns.
4. A method according to any one of the preceding claims wherein the electrodes
20 are separated by less than 200 microns.
5. A method according to any one of the preceding claims wherein the working electrode extends in a plane parallel to and facing the plane in which the counter electrode extends

6. A method according to claim 1 wherein the potential is reversed repetitively and the concentration of the species is estimated as an average from the result obtained prior to each reversal.
7. A method according to any one of the preceding claims wherein the cell
5 contains an enzyme and a redox mediator.
8. A method according to any one of the preceding claims wherein the cell contains GOD.
9. A method according to any one of the preceding claims wherein the cell contains ferricyanide.
- 10 10. A method according to any one of the preceding claims wherein the sample is allowed to react with an enzyme catalyst and a redox mediator said method comprising the prior step of operating the cell at a potential higher than that of the redox reaction so as to oxidise hydrogen peroxide at the anode.
11. A method according to any one of the preceding claims wherein the sample is
15 allowed to react with an enzyme catalyst and a redox mediator further comprising the steps of:
- (a) applying a potential between the electrodes before or during filling of the cell,
 - (b) measuring the increase in current as a function of time,
 - 20 (c) determining or predicting from the measurement in step (b) the time of completion of reaction with said catalyst, and
 - (d) then interrupting, or reversing the polarity, of the potential.

12. A method according to any one of the preceding claims further comprising a second cell containing a known concentration of analyte or reduced mediator and wherein the second cell is used to calibrate the first.
13. A method according to any one of the preceding claims wherein a known
5 concentration of analyte or reduced mediator is added to the analyte and used for calibration.

1/9

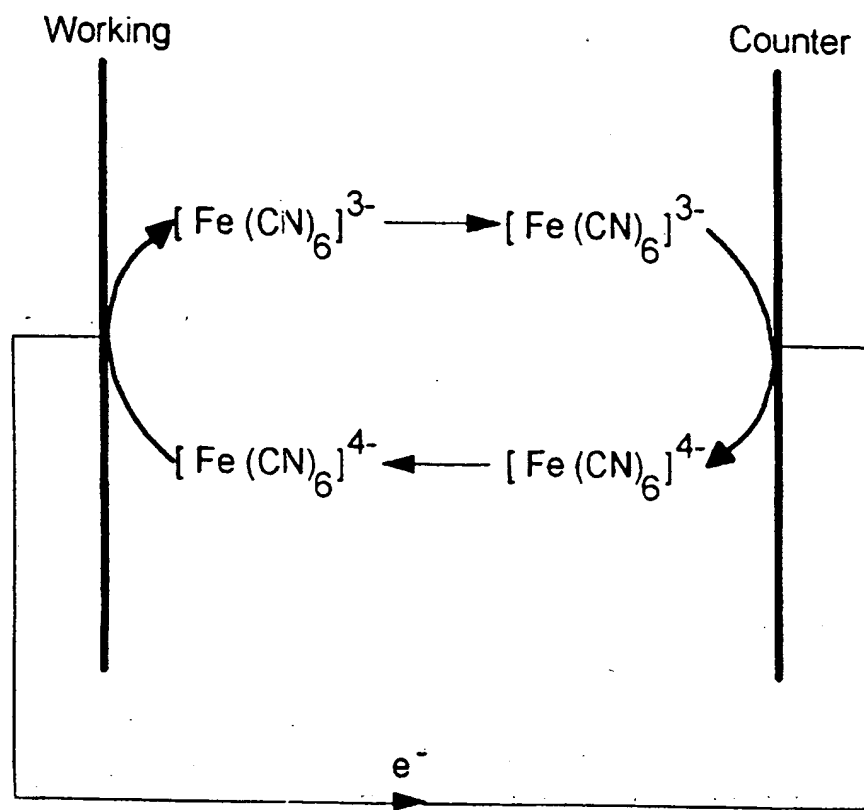

FIGURE 1

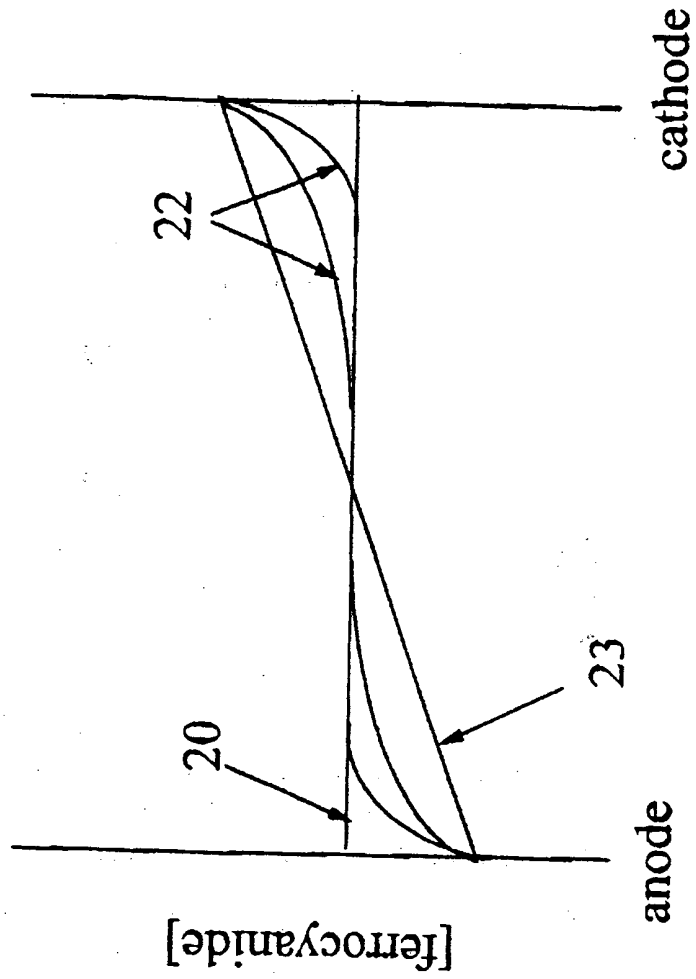
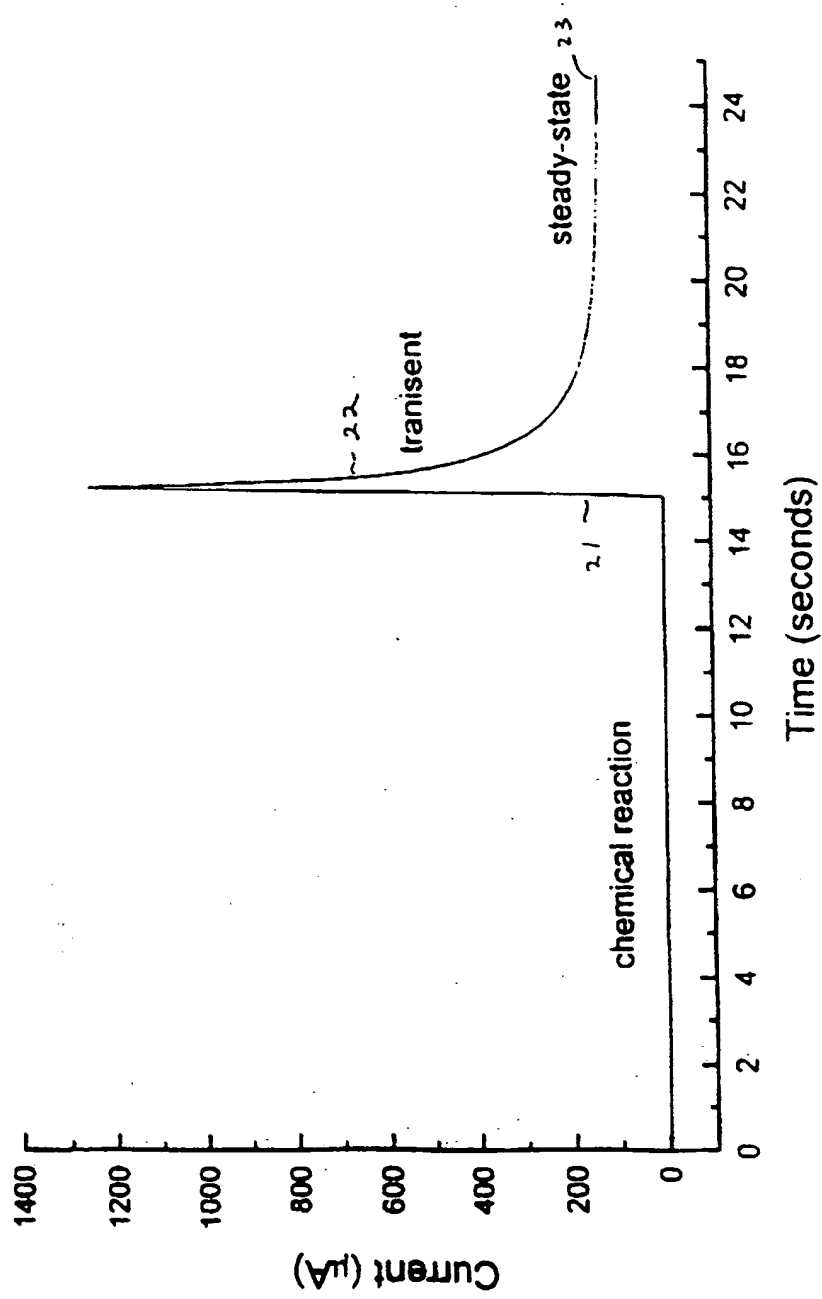

FIGURE 2

FIGURE 3



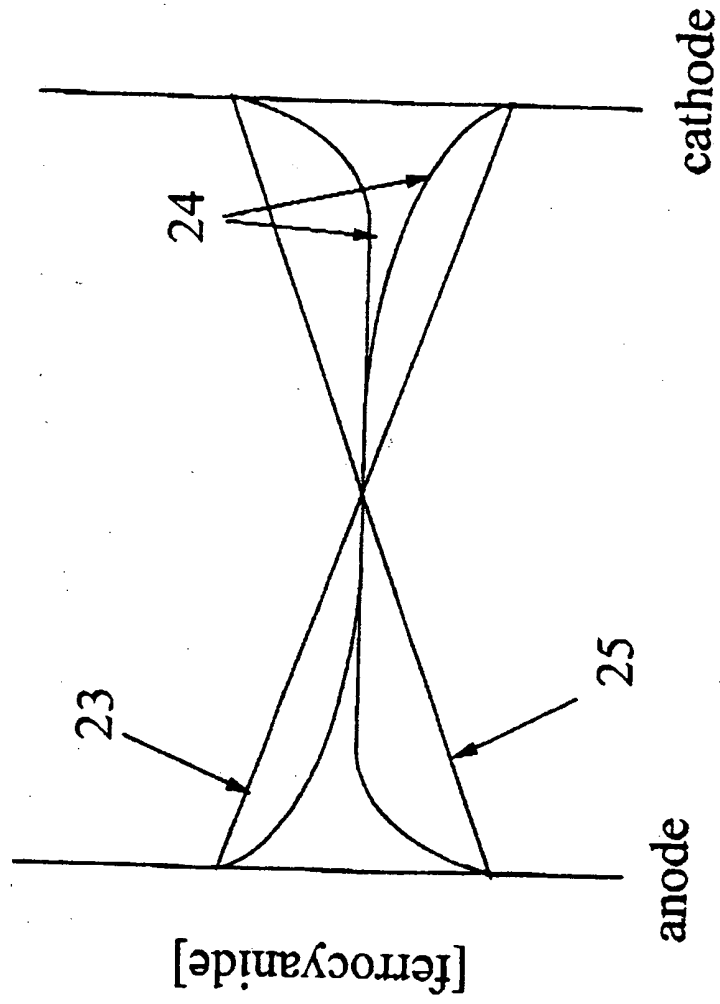

FIGURE 4

FIGURE 5

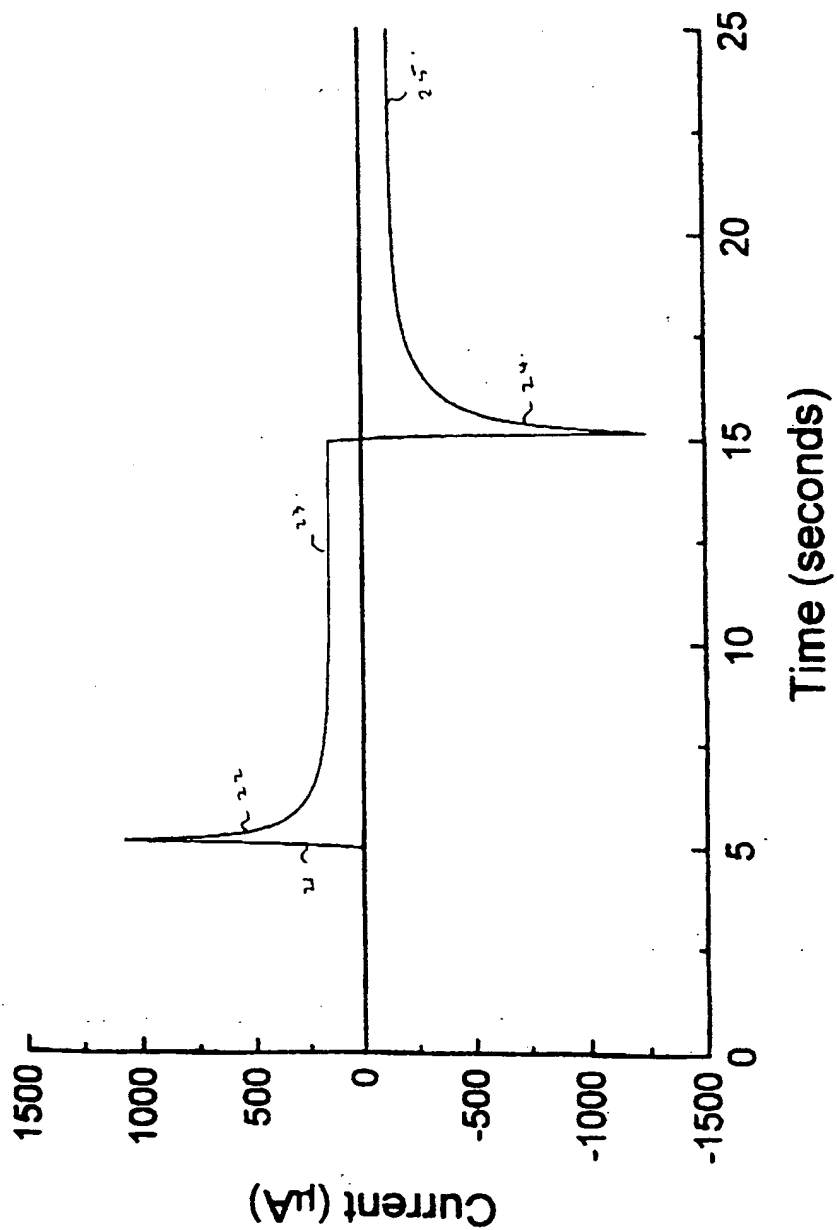
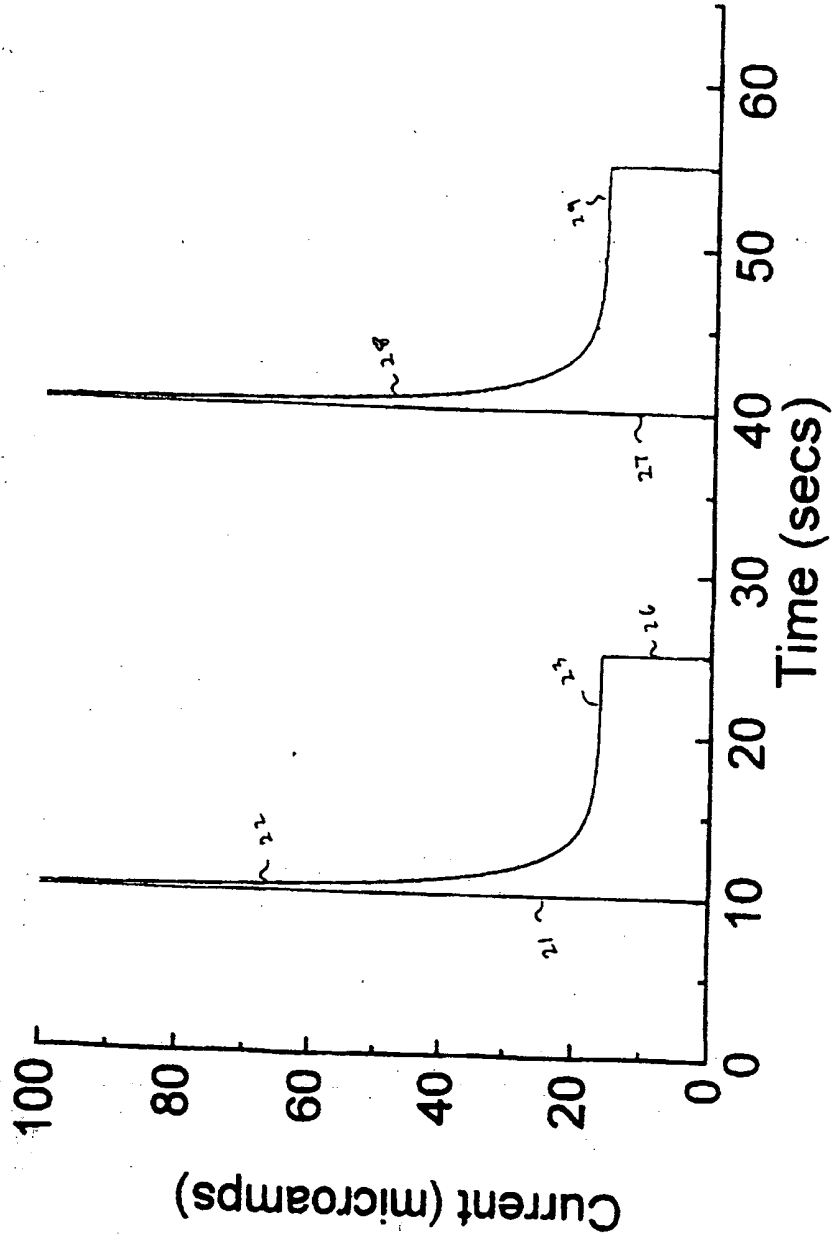

FIGURE 6



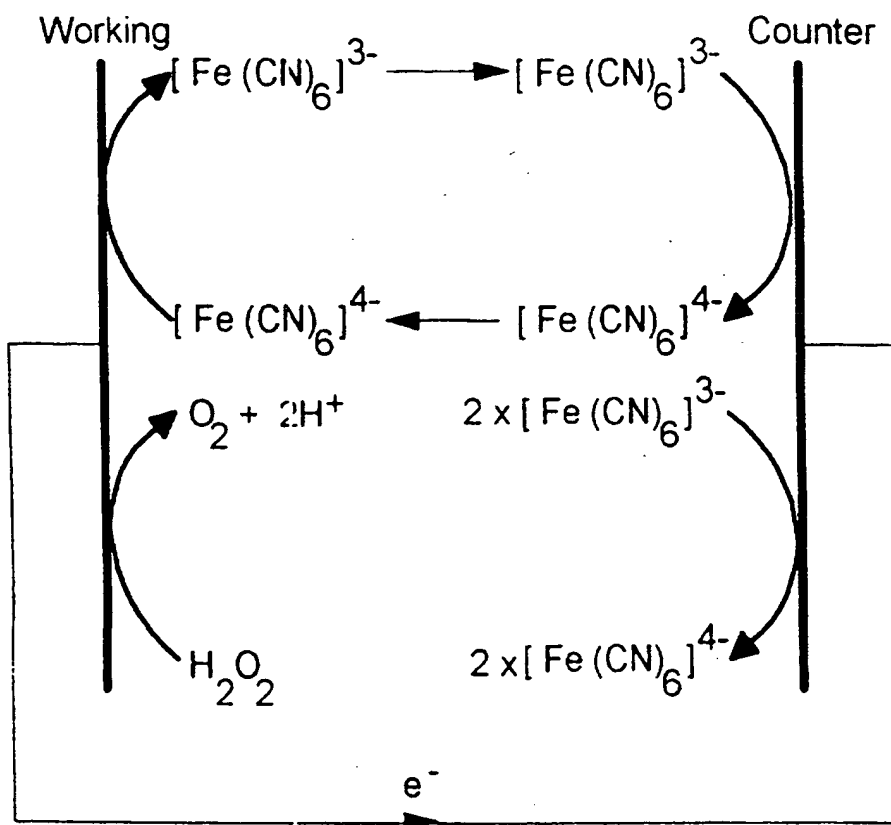
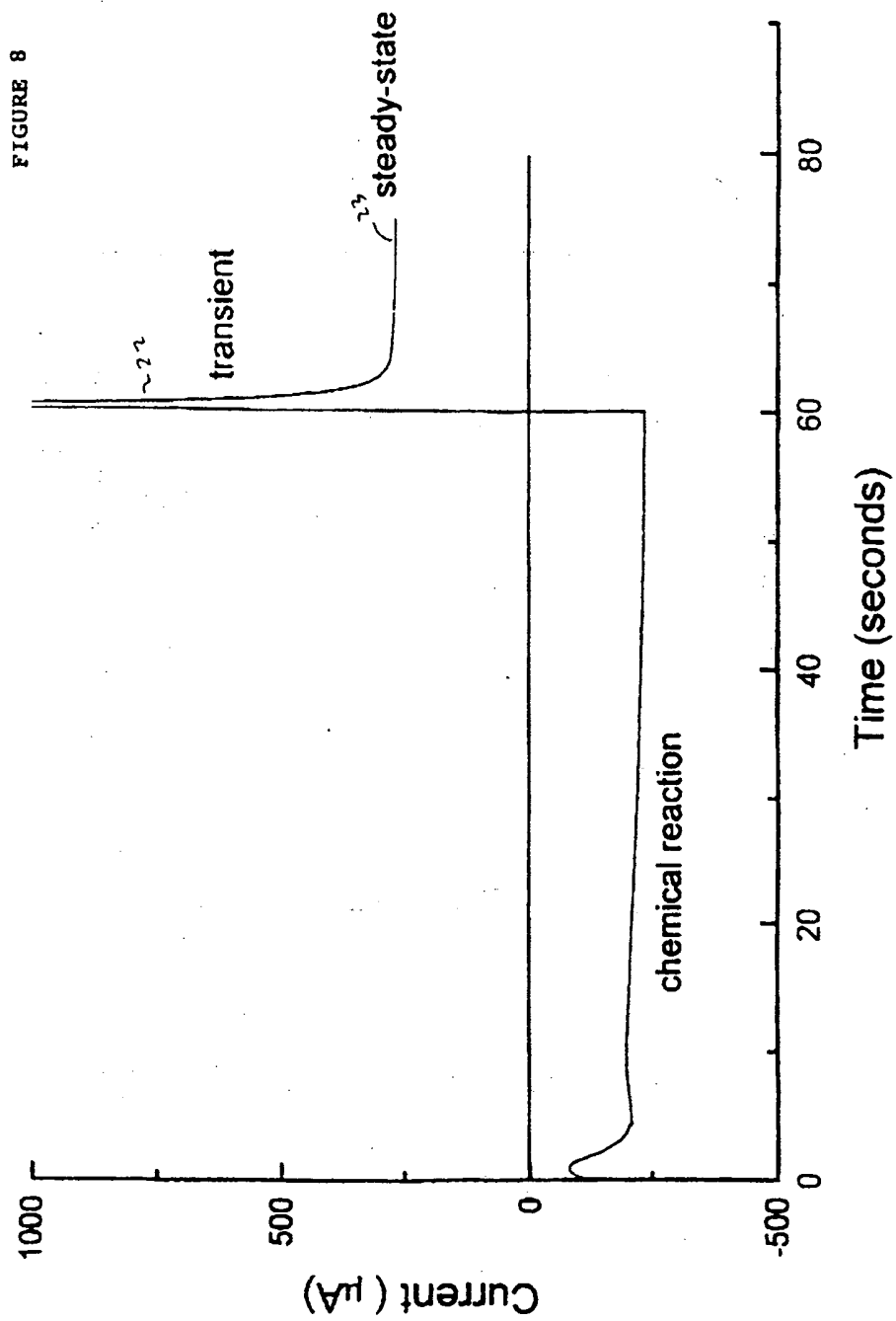

FIGURE 7



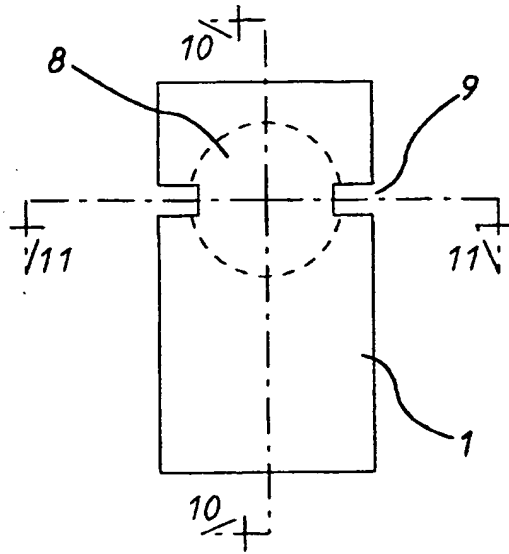

FIG. 9

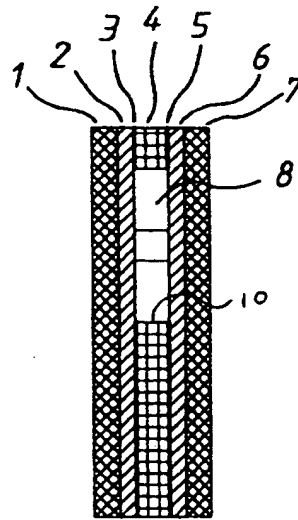

FIG. 10

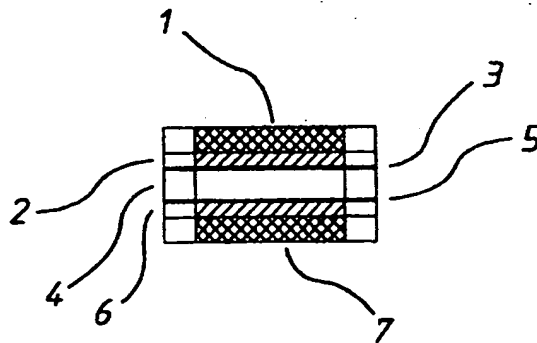
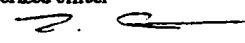

FIG. 11

INTERNATIONAL SEARCH REPORT

International Application No.
PCT/AU 96/00723

A. CLASSIFICATION OF SUBJECT MATTER		
Int Cl ⁶ : G01N 27/42 27/52 27/49		
According to International Patent Classification (IPC) or to both national classification and IPC		
B. FIELDS SEARCHED		
Minimum documentation searched (classification system followed by classification symbols) IPC : G01N 27/42 27/52 27/49		
Documentation searched other than minimum documentation to the extent that such documents are included in the fields searched AU : IPC as above		
Electronic data base consulted during the international search (name of data base and, where practicable, search terms used)		
C. DOCUMENTS CONSIDERED TO BE RELEVANT		
Category*	Citation of document, with indication, where appropriate, of the relevant passages	Relevant to claim No.
A	EP 255291 A (UNILEVER NV) 3 February 1988 the whole document	1-13
A	WO 94/02842 A (THE VICTORIA UNIVERSITY OF MANCHESTER) 3 February 1994 the whole document	1-13
A	AU 31042/93 A (COMMONWEALTH SCIENTIFIC AND INDUSTRIAL RESEARCH ORGANISATION) 15 July 1993 the whole document	1-13
<input checked="" type="checkbox"/> Further documents are listed in the continuation of Box C <input checked="" type="checkbox"/> See patent family annex		
* Special categories of cited documents: "A" document defining the general state of the art which is not considered to be of particular relevance "E" earlier document but published on or after the international filing date "L" document which may throw doubts on priority claim(s) or which is cited to establish the publication date of another citation or other special reason (as specified) "O" document referring to an oral disclosure, use, exhibition or other means "P" document published prior to the international filing date but later than the priority date claimed "T" later document published after the international filing date or priority date and not in conflict with the application but cited to understand the principle or theory underlying the invention "X" document of particular relevance; the claimed invention cannot be considered novel or cannot be considered to involve an inventive step when the document is taken alone "Y" document of particular relevance; the claimed invention cannot be considered to involve an inventive step when the document is combined with one or more other such documents, such combination being obvious to a person skilled in the art "&" document member of the same patent family		
Date of the actual completion of the international search 3 December 1996		Date of mailing of the international search report 22.01.97
Name and mailing address of the ISA/AU AUSTRALIAN INDUSTRIAL PROPERTY ORGANISATION PO BOX 200 WODEN ACT 2606 AUSTRALIA Facsimile No.: (06) 285 3929		Authorized officer  Z. STANOJEVIC Telephone No.: (06) 283 2168

INTERNATIONAL SEARCH REPORT

International Application No.
PCT/AU 96/00723

C (Continuation) DOCUMENTS CONSIDERED TO BE RELEVANT		
Category*	Citation of document, with indication, where appropriate, of the relevant passages	Relevant to claim No.
A	US 453340 A (KIM) 6 August 1985 the whole document	1-13

INTERNATIONAL SEARCH REPORT

International Application No.

Information on patent family members

PCT/AU 96/00723

This Annex lists the known "A" publication level patent family members relating to the patent documents cited in the above-mentioned international search report. The Australian Patent Office is in no way liable for these particulars which are merely given for the purpose of information.

Patent Document Cited in Search Report		Patent Family Member			
EP	255291	EP	470649	ES	2033854
WO	9402842	AU	47160/93		
END OF ANNEX					

**This Page is Inserted by IFW Indexing and Scanning
Operations and is not part of the Official Record**

BEST AVAILABLE IMAGES

Defective images within this document are accurate representations of the original documents submitted by the applicant.

Defects in the images include but are not limited to the items checked:

- BLACK BORDERS**
- IMAGE CUT OFF AT TOP, BOTTOM OR SIDES**
- FADED TEXT OR DRAWING**
- BLURRED OR ILLEGIBLE TEXT OR DRAWING**
- SKEWED/SLANTED IMAGES**
- COLOR OR BLACK AND WHITE PHOTOGRAPHS**
- GRAY SCALE DOCUMENTS**
- LINES OR MARKS ON ORIGINAL DOCUMENT**
- REFERENCE(S) OR EXHIBIT(S) SUBMITTED ARE POOR QUALITY**
- OTHER:** _____

IMAGES ARE BEST AVAILABLE COPY.

As rescanning these documents will not correct the image problems checked, please do not report these problems to the IFW Image Problem Mailbox.

This Page Blank (uspto)